

# BEACHFLAG

## I. Montáž konstrukce

A + B + C

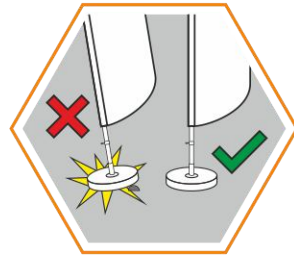
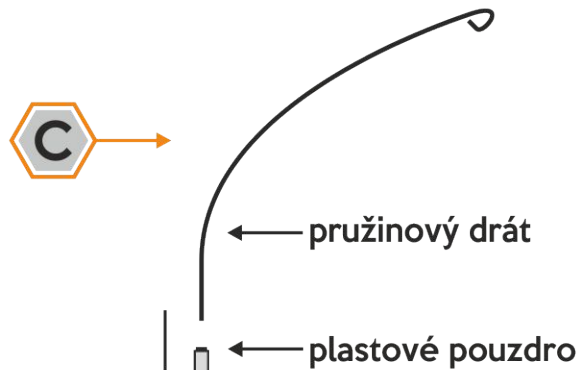

B

konstrukce  
Premium KLIK

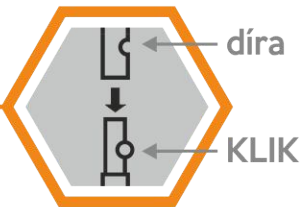

konstrukce  
Klasik

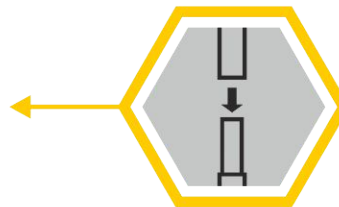



A

A1

- Pospojte hliníkové trubky tak, aby zámek zapadl do "KLIK" u. (u Premium KLIK)
- Horní hliníková trubka má plastové pouzdro pro tyč z pružinové oceli. Tyč z pružinové oceli vložte do plastového pouzdra (cca. 10 cm) až na doraz! Zkontrolujte, zda je pružinová ocelová tyč pevně v plastovém pouzdře!
- Umístěte vlajku na konstrukci
- Popruhy na vlajce přivažte k očku (A1).

# BEACHFLAG

## II. Montáž vlajky

  **Vítr**  
max: 20 km/h

Beachflagy jsou určeny výhradně pro dočasné použití díky své lehké konstrukci a



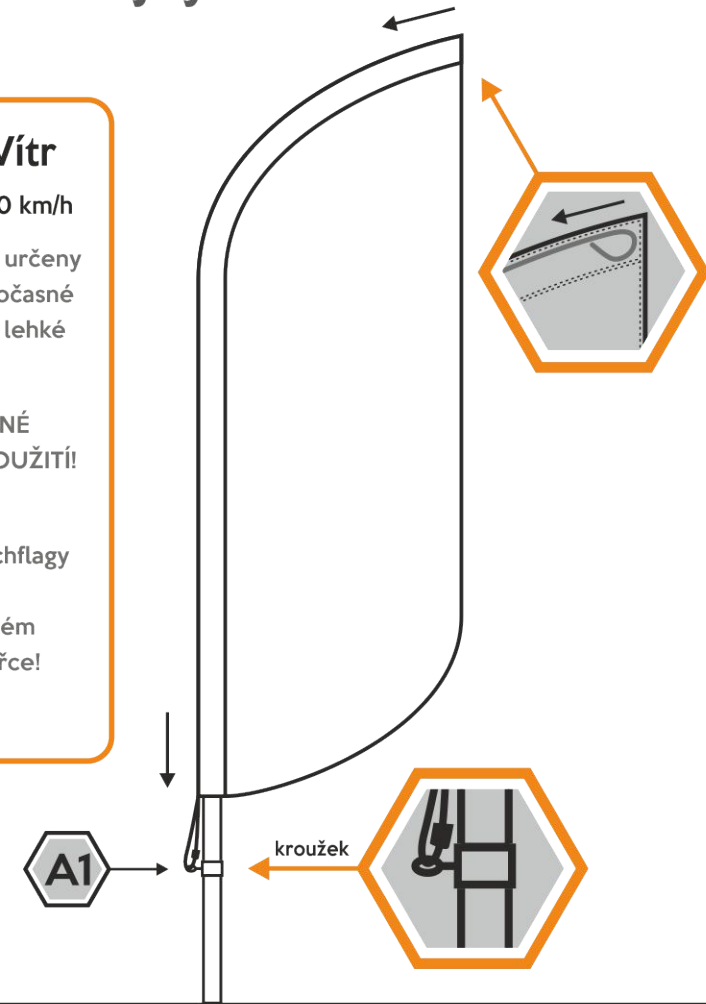

**NEJSOU VHODNÉ PRO TRVALÉ POUŽITÍ!**

Aby nedošlo k poškození, beachflagy by neměly být používány v silném větru nebo bouřce!



### Důležité upozornění:

 **Prosím vezměte na vědomí, že vlajka by měla být před prvním použitím vypraná.**

Ošetrovací symboly:     

100% POLYESTER

# BEACHFLAG GRAND

## GRAND 1,6

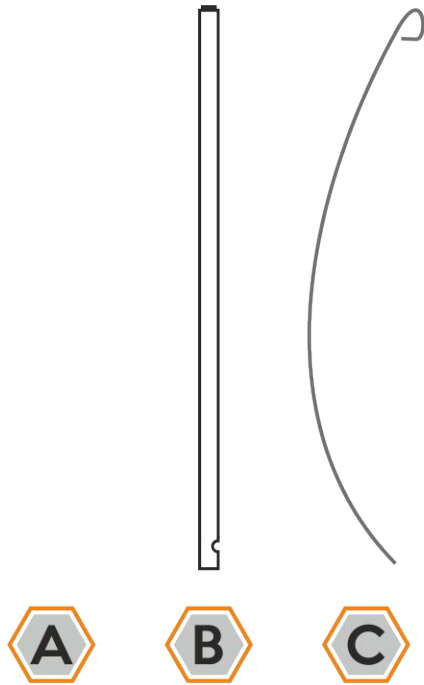

Aluminium  
Art: G-0/1/G1

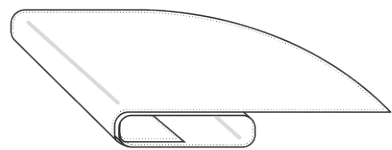

Flag



Transportbag

## GRAND 2,6

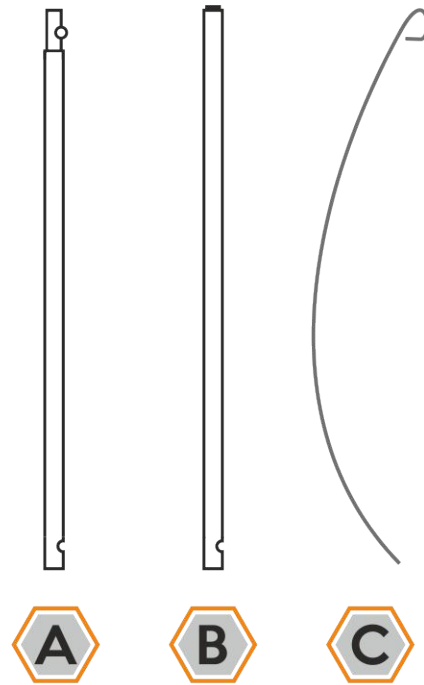

Aluminium  
Art: G-1/1/G1

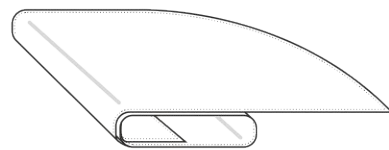

Flag



Transportbag

## GRAND 3,6

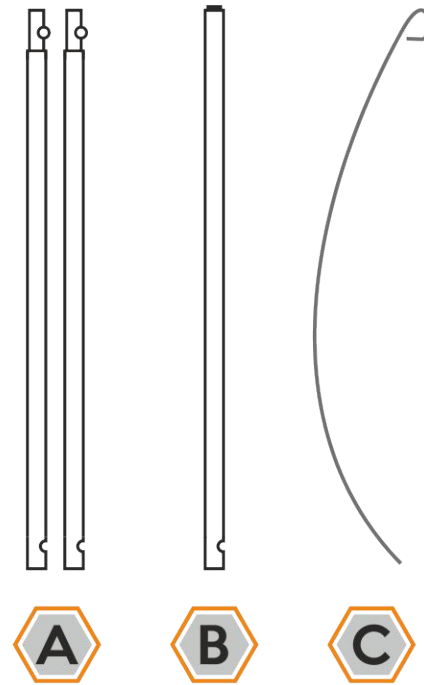

Aluminium  
Art: G-2/1/G1

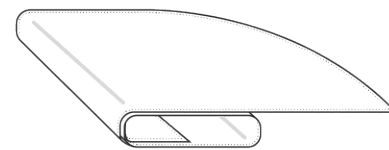

Flag



Transportbag

## GRAND 4,6

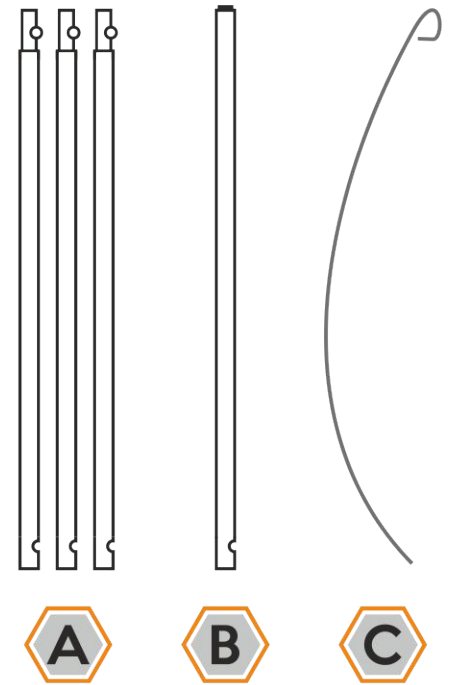

Aluminium  
Art: G-3/1/G1

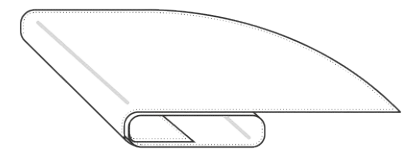

Flag



Transportbag